



## OPERATOR AND SERVICE MANUAL



**MODEL NUMBER: 22-78**

**SERIAL NUMBER (Record Below):**

\_\_\_\_\_  
TO LOCATE YOUR SERIAL NUMBER, SEE PAGE 7



14460 Maple Inn Rd SE  
Mentor, MN 56736  
[www.muskoxmn.com](http://www.muskoxmn.com)

Document Release Date: 01-01-22  
Part #: 0309-201

# TABLE OF CONTENTS

<b>PREFACE</b> .....	<b>3</b>
Safety Statements .....	4
General Safety Precautions .....	4
Equipment Safety Precautions .....	6
Safety Decals .....	6
Safety Decal Locations .....	7
<b>INSTALLATION AND SETUP</b> .....	<b>8</b>
Hydraulic Connections .....	9
<b>OPERATION</b> .....	<b>10</b>
<b>LIFT POINTS</b> .....	<b>12</b>
<b>TIE DOWN POINTS</b> .....	<b>12</b>
<b>GENERAL STORAGE</b> .....	<b>13</b>
<b>MAINTENANCE</b> .....	<b>14</b>
Grease Points .....	14
Service Videos .....	15
<b>TROUBLESHOOTING</b> .....	<b>16</b>
<b>BOLT TORQUE SPECIFICATIONS</b> .....	<b>17</b>
<b>WARRANTY</b> .....	<b>18</b>



For the most updated information on MUSKOX products and services, please visit [www.muskoxmn.com/22-78-maintenance-videos](http://www.muskoxmn.com/22-78-maintenance-videos). There you will find service and maintenance videos, tips, advice and more.

# PREFACE

## GENERAL INFORMATION

This product was carefully designed and manufactured. Only minor maintenance (such as cleaning and lubricating) is required to keep it in top working condition. Be sure to observe all maintenance procedures and safety precautions in this manual and on any safety decals located on the product and on any equipment on which the attachment is mounted.

## WARNING!



Never let anyone operate this unit without reading the “Safety Precautions” and “Operating Instructions” sections of this manual. Always choose hard, level ground to park the vehicle on and set the brake so the unit cannot roll.

**NOTE:** The illustrations and data used in this manual were current (according to the information available to us) at the time of printing, however, we reserve the right to redesign and change the attachment as may be necessary without notification.

## BEFORE OPERATION



### SAFETY ALERT & WARNING SYMBOLS

These are the “Safety Alert & Warning Symbols” used by this industry. These symbols are used to warn of possible injury. Be sure to read all warnings carefully. They are included for your safety and the safety of others working with you.

The primary responsibility for safety with equipment falls to the operator. Make sure the equipment is operated only by trained individuals that have read and understand this manual. If there is any portion of this manual or function you do not understand, contact your local authorized dealer or manufacturer to obtain further assistance. Keep this manual available for reference. Provide this manual to any new owners and/or operators.

## SERVICE

Use only manufacturer replacement parts. Substitute parts may not meet the required standards. Record the model and serial number of your unit on the cover of this manual. The parts department needs this information to ensure that you receive the correct parts.

## SOUND AND VIBRATION

Sound pressure levels and vibration data for this attachment are influenced by many different parameters; some items are listed below (not inclusive):

- prime mover type, age, condition, with or without cab enclosure and configuration
- operator training, behavior, stress level
- job site organization, working material condition, environment

Based on the uncertainty of the prime mover, operator, and job site, it is impossible to get precise machine and operator sound pressure levels, or vibration levels for this attachment.



Unless noted otherwise, right and left sides are determined from the operator’s control position when facing the attachment.

# SAFETY STATEMENTS

## SAFETY DEFINITIONS

The purpose of safety symbols is to attract your attention to possible dangers. The safety symbols, and their explanations, deserve your careful attention and understanding. The safety warnings do not by themselves eliminate any danger. The instructions or warnings they give are not substitutes for proper accident prevention measures.

### DANGER



Danger indicates a hazardous situation which, if not avoided, will result in death or serious injury.

### WARNING



Warning indicates a hazardous situation which, if not avoided, could result in death or serious injury.

### CAUTION



Caution indicates a hazardous situation which, if not avoided, could result in minor or moderate injury.

### NOTICE



Notice indicates information considered important, but not hazard-related (e.g. messages relating to property damage).



This symbol by itself or used with a warning word throughout this manual is used to call your attention to instructions involving your personal safety or the safety of others. Failure to follow these instructions can result in injury or death.

# GENERAL SAFETY PRECAUTIONS

## READ MANUAL PRIOR TO INSTALL



Improper installation, operation, or maintenance of this equipment could result in serious injury or death. Operators and maintenance personnel should read this manual as well as all manuals related to this equipment and the prime mover thoroughly before beginning installation, operation, or maintenance. **FOLLOW ALL SAFETY INSTRUCTIONS IN THIS MANUAL AND THE PRIME MOVER'S MANUAL.**

## READ AND UNDERSTAND ALL SAFETY STATEMENTS



Read all safety decals and safety statements in all manuals prior to operating or working on this equipment. Know and obey all OSHA regulations, local laws and other professional guidelines for your operation. Know and follow good work practices when assembling, maintaining, repairing, mounting, removing or operating this equipment.

## KNOW YOUR EQUIPMENT



Know your equipment's capabilities, dimensions and operations before operating. Visually

inspect your equipment before you start, and never operate equipment that is not in proper working order with all safety devices intact. Check all hardware to assure it is tight. Make certain that all locking pins, latches, and connection devices are properly installed and secured. Remove and replace any damaged, fatigued or excessively worn parts. Make certain all safety decals are in place and are legible. Keep decals clean, and replace them if they become worn and hard to read. **(Safety decal replacements are available free of charge from the manufacturer).**

## PROTECT AGAINST FLYING DEBRIS



Always wear proper safety glasses, goggles or a face shield when driving pins in or out or when operation causes dust, flying debris, or any other hazardous material.

## LOWER OR SUPPORT RAISED EQUIPMENT



Do not work under raised booms without supporting them. Do not use support material made of concrete blocks, logs, buckets, barrels or any other material that could suddenly collapse or shift

positions. Make sure support material is solid, not decayed, warped, twisted, or tapered. Lower booms to ground level or onto blocks. Lower booms and attachments to the ground before leaving the cab or operator's station.

## DO NOT MODIFY MACHINE OR ATTACHMENTS

 Modifications may weaken the integrity of the attachment and may impair the function, safety, life and performance of the attachment. When making repairs, use only the manufacturer's genuine parts, following authorized instructions. Other parts may be substandard in fit and quality. Never modify any ROPS (Roll Over Protection System) equipment or device. Any modifications must be authorized in writing by the manufacturer.

## SAFELY MAINTAIN AND REPAIR EQUIPMENT

 Do not wear loose clothing, or any accessories that can catch in moving parts. If you have long hair, cover or secure it so that it does not become entangled in the equipment.

- Work on a level surface in a well-lit area.
- Use properly grounded electrical outlets and tools.
- Use the correct tool for the job at hand. Make

sure they are in good condition for the task required.

- Wear the protective equipment specified by the tool manufacturer.

## SAFELY OPERATE EQUIPMENT

 Do not operate equipment until you are completely trained by a qualified operator in how to use the controls, know its capabilities, dimensions, and all safety requirements. See your prime mover's manual for these instructions.

- Keep all step plates, grab bars, pedals, and controls free of dirt, grease, debris, and oil.
- Never allow anyone to be around the equipment when it is operating.
- Do not allow riders on the attachment or the prime mover.
- Do not operate the equipment from anywhere other than the correct operator's position.
- Never leave equipment unattended with the engine running or with this attachment in a raised position.
- Do not alter or remove any safety features from the prime mover or this attachment.
- Know your work site safety rules as well as traffic rules and flow. When in doubt on any safety issue, contact your supervisor or safety coordinator for an explanation.

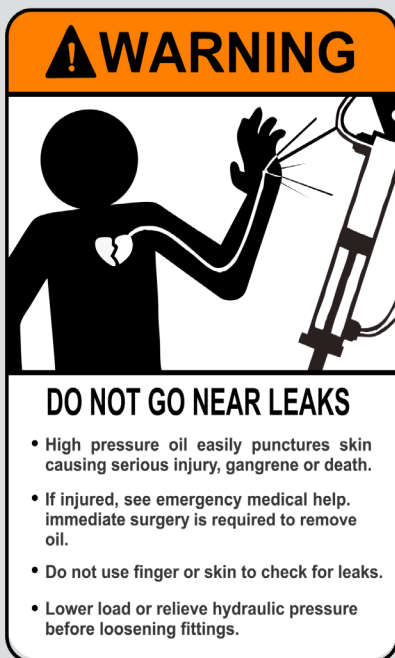

## USE CARE WITH HYDRAULIC FLUID PRESSURE

 Hydraulic fluid under pressure can penetrate the skin and cause serious injury or death. Hydraulic leaks under pressure may not be visible. Before connecting or disconnecting hydraulic hoses, read your prime movers operator's manual for detailed instructions on connecting and disconnecting hydraulic hoses or fittings.

- Keep unprotected body parts, such as face, eyes, and arms as far away as possible from a suspected leak. Flesh injected with hydraulic fluid may develop gangrene or other permanent disabilities.
- If injured by injected fluid, see a doctor at once. If your doctor is not familiar with this type of injury, ask him to research immediately to determine proper treatment.
- Wear safety glasses, protective clothing, and use a sound piece of cardboard or wood when searching for hydraulic leaks.

**DO NOT USE YOUR HANDS!**



# EQUIPMENT SAFETY PRECAUTIONS

## REMOVE PAINT BEFORE WELDING OR HEATING

 Hazardous fumes/dust can be generated when paint is heated by welding, soldering or using a torch. Do all work outside or in a well-ventilated area and dispose of paint and solvent properly. Remove paint before welding or heating.

When sanding or grinding paint, avoid breathing the dust. Wear an approved respirator. If you use solvent or paint stripper, remove stripper with soap and water before welding. Remove solvent or paint stripper containers and other flammable material from area. Allow fumes to disperse at least 15 minutes before welding or heating.

## END OF LIFE DISPOSAL

 At the completion of the useful life of the unit, drain all fluids and dismantle by separating the different materials (rubber, steel, plastic, etc.). Follow all federal, state and local regulations for recycling and disposal of the fluid and components.

## KNOW WHERE UTILITIES ARE

 Observe overhead electrical and other utility lines. Be sure equipment will clear them. When

digging, call your local utilities for location of buried utility lines, gas, water, and sewer, as well as any other hazard you may encounter.

## ROTATING OBJECTS

 Never allow anyone to reach into, kick into, or otherwise come in contact with a rotating auger or with a non-rotating clogged auger. The auger can crush and/or dismember. Keep everyone clear of the auger until the prime mover engine is off and the hydraulic pressure has been relieved.

Never allow anyone to reach into the chute, force objects (i.e. bars, poles, etc.) down the chute, kick into the fan, or otherwise come in contact with a rotating fan or with a non-rotating clogged fan. The fan can throw objects at a lethal speed and can dismember. Keep everyone clear of the fan until the prime mover engine is off and the hydraulic pressure has been relieved.

## AVOID PINCH POINTS

 Avoid pinch points and be aware of rotating parts when manually turning the fan or auger.

# SAFETY DECALS



**0309-115**  
**WARNING:** Rotating Auger  
**WARNING:** Tip Over Hazard



**0309-109**  
**WARNING:** Flying Debris



**0309-114**  
**WARNING:** Pinch Point

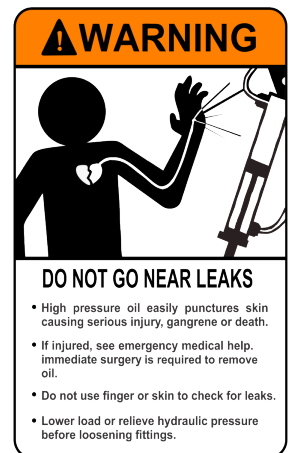

**0309-110**  
**WARNING:** High Pressure Fluid

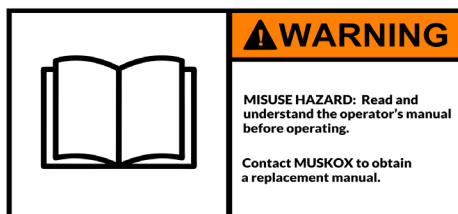

**0309-116**  
**WARNING:** Read Manual



**0309-102**  
**WARNING:** Chain



**0309-101**  
**WARNING:** Rotating Objects

# SAFETY DECAL LOCATIONS

## INSTRUCTIONS

- Keep all safety signs clean and legible.
- Replace all missing, illegible, or damaged safety signs.
- Replacement parts for parts with safety signs attached must also have safety signs attached. Safety signs are available, free of charge from MUSKOX.

## PLACEMENT OR REPLACEMENT OF SAFETY SIGNS

1. Clean the area of application with non-flammable solvent, and then wash the same area with soap and water.
2. Allow the surface to fully dry.
3. Remove the backing from the safety sign, exposing the adhesive surface.
4. Apply the safety sign to the position shown in the diagram below and smooth out any bubbles.

**SAFETY AND BRAND DECAL LOCATIONS**

It is directly above the motor size and model stickers on the fan housing

ITEM	PART	QTY	DESCRIPTION
1	0309-111	1	Lg. MuskoX Logo
2	0309-108	3	Med. MuskoX Logo
3	0309-106	1	Sm. MuskoX Logo
4	0309-115	1	Auger/Tip Over Warning
5	0309-109	2	Flying Debris Warning
6	0309-101	2	Rotating Objects Warning
7	0309-116	1	Read Manual Warning
8	0309-110	1	High Pressure Fluid Warning
9	0309-118	1	Model Number
10	0309-102	1	Chain Warning
11	0309-114	2	Pinch Point Warning
12	0309-112	1	Patent Pending
13		1	Serial Number
	0309-100	1	Brand Decal Kit
	0309-113	1	Safety Decal Kit

# INSTALLATION AND SETUP

## INSTALLATION & SETUP

1. Place the product on a firm, level surface that is large enough to safely accommodate this product, your prime mover and all workers involved in the mounting process.
2. Refer to the operator's manual(s) for your prime mover, loader, and quick-attach and follow the mounting instructions contained therein.
3. Carefully raise the loader and cycle the tilt cylinders to check clearances and to verify that all mounting procedures have been successfully completed.



**Lubricate all grease fittings before connecting this product to your prime mover's hydraulic system.**

**Refer to the MAINTENANCE section on page 14, and follow the instructions**

## WIRING HARNESS INSTALLATION

1. Remove the ground cable from the negative (-) post of your prime mover's battery.

2. Remove the nut from the POSITIVE (+) cable clamp on the battery and slide the RED wire ring terminal from the wiring harness cable over the positive (+) cable clamp bolt. Secure the ring terminal with the nut.
3. Remove the nut from the NEGATIVE (-) cable clamp on the ground cable and slide the BLACK wire ring terminal from the wiring harness cable over the negative (-) cable clamp bolt.
4. Reinstall the ground cable on the negative post of the battery and secure the ring terminal and the ground cable with the nut removed in the previous step.
5. Secure the wiring harness cable from the battery to the control box with your nylon cable ties.
6. Feed the wiring harness cable: a) back to the left-rear area of your prime mover, b) past the loader arm's rear hinge point by following the hydraulic hoses where possible, and c) down the loader arm following the hydraulic lines.
7. Allow sufficient slack in the cable at the hinge point to provide for a full range of motion of the loader arms. Use your nylon cable ties to secure the cable to the loader frame below the hinge point and back to the control box.



### READ MANUAL PRIOR TO INSTALLATION

Improper installation, operation, or maintenance of this equipment could result in serious injury or death. Operators and maintenance personnel should read this manual, as well as all manuals related to this equipment and the prime mover thoroughly before beginning installation, operation, or maintenance. **FOLLOW ALL SAFETY INSTRUCTIONS IN THIS MANUAL AND THE PRIME MOVER'S MANUAL(S).**

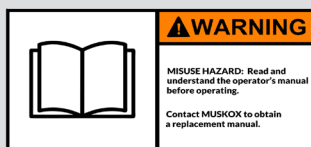

#### WARNING

**MISUSE HAZARD:** Read and understand the operator's manual before operating.  
Contact MUSKOX to obtain a replacement manual.

**WARNING!** Failure to obey the following procedures could result in death or serious injury. Before doing any work on your prime mover's battery, read and understand all prime mover instructions and safety signs for your prime mover's electrical system. Pay special attention to hazard avoidance and remedial action related to explosive gas and acid.

**AVOID ELECTRIC SHOCK!** Failure to obey all procedures may result in personal injury. To avoid electrical shock during the wiring harness installation, remove the ground cable from the battery of your prime mover.



# HYDRAULIC CONNECTIONS

## HYDRAULIC SNOW BLOWER HYDRAULIC CONNECTION

1. Disconnect the hydraulic hose quick couplers from one another and attach the quick couplers to your prime mover as per the instructions in your prime mover operator's manual. (Also see Hydraulic Hose Connections on page 14 of this manual).
2. Carefully raise the loader and cycle the tilt cylinders to check hose clearances and to check for any interference. Operate the

chute and deflector on this product to make the same checks.

3. Cycle the hydraulic cylinder(s) on this product several times from fully retracted to fully extended until all air has been completely removed from the cylinder(s).



**WARNING!** Do not lock the auxiliary hydraulics of your prime mover in the "ON" position. Failure to obey this warning could result in death or serious injury.

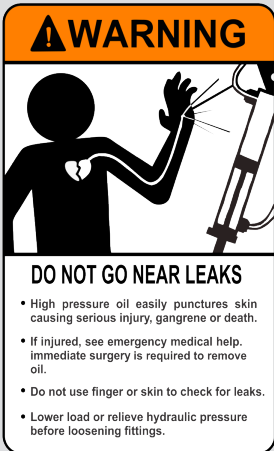

### READ AND UNDERSTAND ALL SAFETY STATEMENTS

Read all safety decals and safety statements in all manuals before beginning any Snow Blower hydraulic connection. Know and obey all OSHA regulations, local laws, and other professional guidelines for your operation. Know and follow good work practices when assembling, maintaining, repairing, mounting, removing, or operating this equipment.

**WARNING!** Do not lock the auxiliary hydraulics of your prime mover in the "ON" position. Failure to obey this warning could result in death or serious injury.

# OPERATION

## INTENDED USE

This snow blower has been designed and built to push loose snow. Use in any other way is considered contrary to the intended use. Compliance with and strict adherence to operation, service and repair conditions as specified by the manufacturer, are also essential elements of the intended use.

 Never allow anyone to reach into, kick into, or otherwise come in contact with a rotating auger or with a non-rotating clogged auger. The auger can crush and/or dismember. Keep everyone clear of the auger until the prime mover engine is off and the hydraulic pressure has been relieved.

 Never allow anyone to reach into the chute, force objects (i.e. bars, poles, etc.) down the chute, kick into the fan, or otherwise come in contact with a rotating fan or with a nonrotating clogged fan. The fan can throw objects at a lethal speed and can dismember. Keep everyone clear of the fan until the prime mover engine is off and the hydraulic pressure has been relieved.

 Never place any object (i.e. bar, pole, stick, etc.) down the chute until the prime mover engine is off and the hydraulic pressure has been relieved.

Do not operate this product until all others are clear of the entire discharge area. Foreign objects and pieces of ice are generally thrown farther than snow. High flow snow blowers are capable of throwing material up to up to 90 feet.

Do not operate this product when blowing or thrown snow restricts visibility.

Do not lock the auxiliary hydraulics in the “ON” position.

Never lift this product a) above the operator’s eye level or b) to a height where visibility is obstructed, whichever is lower.

 Be aware that turning off the power unit key does not cut the power to the winch or to the actuator. With the switches for these devices being powered 100 percent of the time, care must be taken to not engage these switches:

- a) Accidentally at any time, especially when entering or leaving the prime mover operator’s position, or
- b) When others are working on or near the actuator, the deflector, the winch, the chute, or any other part of this product that could cause personal injury if the switches are engaged.

## NOTICE

**Holding the toggle switches in the powered position after the actuator has reached the end of that device’s cycle of movement, and/or**

- **Applying force on the deflector from any source, other than blown snow, that will cause the deflector to either compress or extend the deflector’s actuator, and/or**
- **Using your Snow Blower as a snow “plow” CAN result in damage to this product and WILL void all MUSKOX warranties.**

## READ AND UNDERSTAND ALL SAFETY STATEMENTS



Read all safety decals and safety statements in all manuals prior to operating or working on this equipment. Know and obey all OSHA regulations, local laws, and other professional guidelines for your operation. Know and follow good work practices when assembling, maintaining, repairing, mounting, removing, or operating this equipment.



Always rotate the chute and adjust the deflector so that the thrown snow is directed into open areas.

Never direct the discharge at buildings, automobiles, trees, or any other item that may be damaged by thrown snow.

When blowing snow, approach the snow with the wind at the operator's back whenever possible.

When clearing a large area, cut the first pass on the upwind side and work downwind.

If an excessive amount of snow is being pushed in front of the auger housing, **SLOW DOWN!!** Allow the auger and fan enough time to properly collect and throw the snow.

If a foreign object becomes wedged in the auger, the auxiliary hydraulics on the prime mover may

be reversed to reverse the auger. Reversing the auger rotation may remove the obstruction.

If a foreign object becomes wedged in the fan:

- a) Move to a level surface, place your prime mover's transmission in "Park" and engage the parking brake.
- b) Lower this product onto the level surface.
- c) Shut off your prime mover's engine, remove the starter key, wait for all moving parts to come to a stop, and relieve all pressure in the hydraulic lines.
- d) Disconnect the hydraulic fittings from your prime mover and reconnect those fittings to each other.
- e) The fan can then be manually turned in a reverse rotation, allowing the foreign object to be removed.
- f) Once the fan is free, reconnect the hydraulic fittings as per the instructions in the **HYDRAULIC CONNECTION** section of this manual.

# LIFT POINTS

Lift Points are identified in the image below. Lifting at other points is unsafe and can damage attachment. Do not attach lifting accessories around cylinders or in any way that may damage hoses or hydraulic components.

- Attach lifting accessories to unit at recommended lifting points.
- Bring lifting accessories together to a central lifting point.
- Lift gradually, maintaining the equilibrium of the unit.

# TIE DOWN POINTS

Tie down points are identified in the diagram below. Securing to trailer at other points is unsafe and can damage attachment. Do not attach tie down accessories around cylinders or in any way that may damage hoses or hydraulic components.

- Attach tie down accessories to unit as recommended.
- Check unit stability before transporting.

## LIFT POINTS

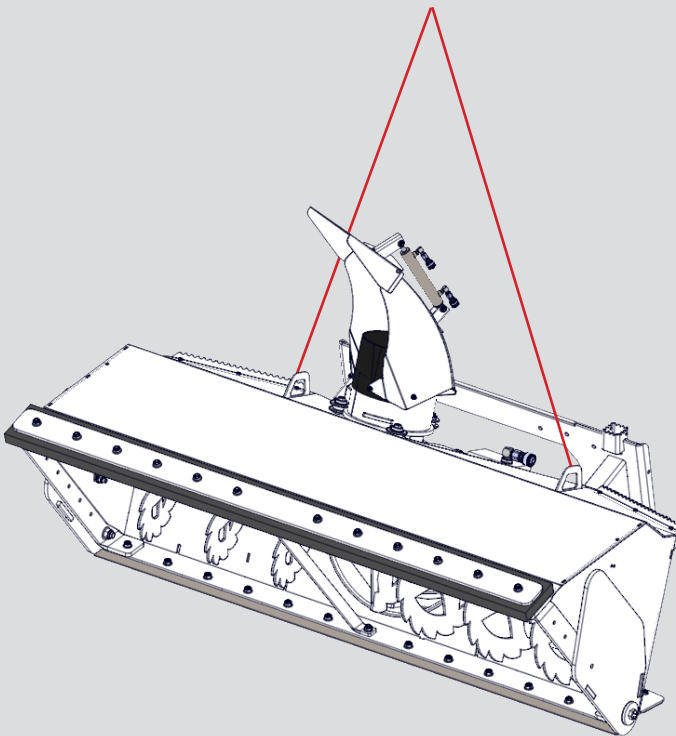

**!** USE LIFTING ACCESSORIES (CHAINS, SLINGS, ROPES, SHACKLES AND ETC.) THAT ARE CAPABLE OF SUPPORTING THE SIZE AND WEIGHT OF YOUR ATTACHMENT. Secure all lifting accessories in such a way to prevent unintended disengagement. Failure to do so could result in the attachment falling and causing serious personal injury or death.

## TIE-DOWN POINTS

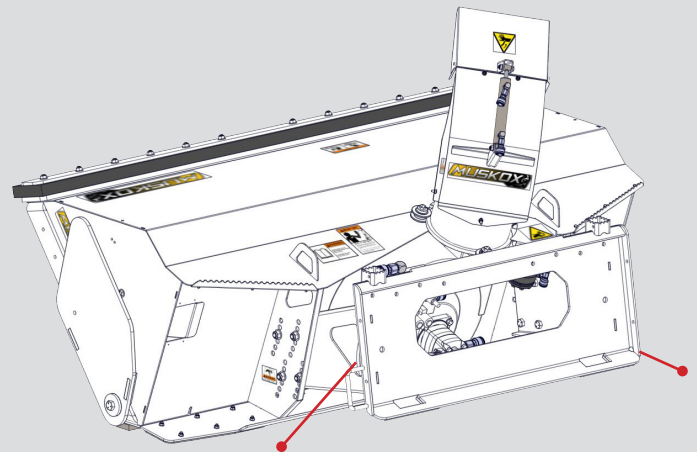

**!** WARNING! VERIFY THAT ALL TIE DOWN ACCESSORIES (CHAINS, SLINGS, ROPES, SHACKLES AND ETC.) ARE CAPABLE OF MAINTAINING ATTACHMENT STABILITY DURING TRANSPORTING and are attached in such a way to prevent unintended disengagement or shifting of the unit. Failure to do so could result in serious personal injury or death.

# GENERAL STORAGE

## STORAGE

- Unit must be stored in the downward (back drag) position.
- Clean the unit thoroughly, removing all snow, dirt and grease.
- Inspect for visible signs of wear, breakage or damage. Order any parts required and make the necessary repairs to avoid delays upon removal from storage.
- Tighten loose nuts, capscrews and hydraulic connections.
- Coat exposed portions of the cylinder rods with grease.
- Lubricate grease fittings.
- Seal hydraulic system from contaminants and secure all hydraulic hoses off the ground to help prevent damage.
- Store unit in a dry and protected place. Leaving the unit outside will materially shorten its life.

- Touch up all unpainted surfaces with paint to avoid rust.

## ADDITIONAL PRECAUTIONS FOR LONG-TERM STORAGE

- Inflate tires to recommended tire pressure.
- Fill fuel tank and hydraulic oil tank to maximum.
- Check antifreeze properties and drain fluids as appropriate.

## REMOVAL FROM STORAGE:

- Remove cover.
- Wash unit and replace any damage and/or missing parts.
- Lubricate grease fittings.
- Check hydraulic hoses for damage and replace as necessary.



# MAINTENANCE

PROCEDURE	BEFORE EACH USE	EVERY 40 HOURS
Check and tighten all hardware and fasteners	X	
Tighten all hydraulic fittings and check for leaks	X	
Check all safety decals that they are clean and legible	X	
Replace any damaged and excessively worn parts	X	
Make sure chute and deflector are not frozen	X	
Grease all fittings as shown on parts illustration below.		X

## READ AND UNDERSTAND ALL SAFETY STATEMENTS

 Read all safety decals and safety statements in all manuals prior to operating or working on this equipment. Know and obey all OSHA regulations, local laws, and other professional guidelines for your operation. Know and follow good work practices when assembling, maintaining, repairing, mounting, removing, or operating this equipment.

## GREASE POINTS

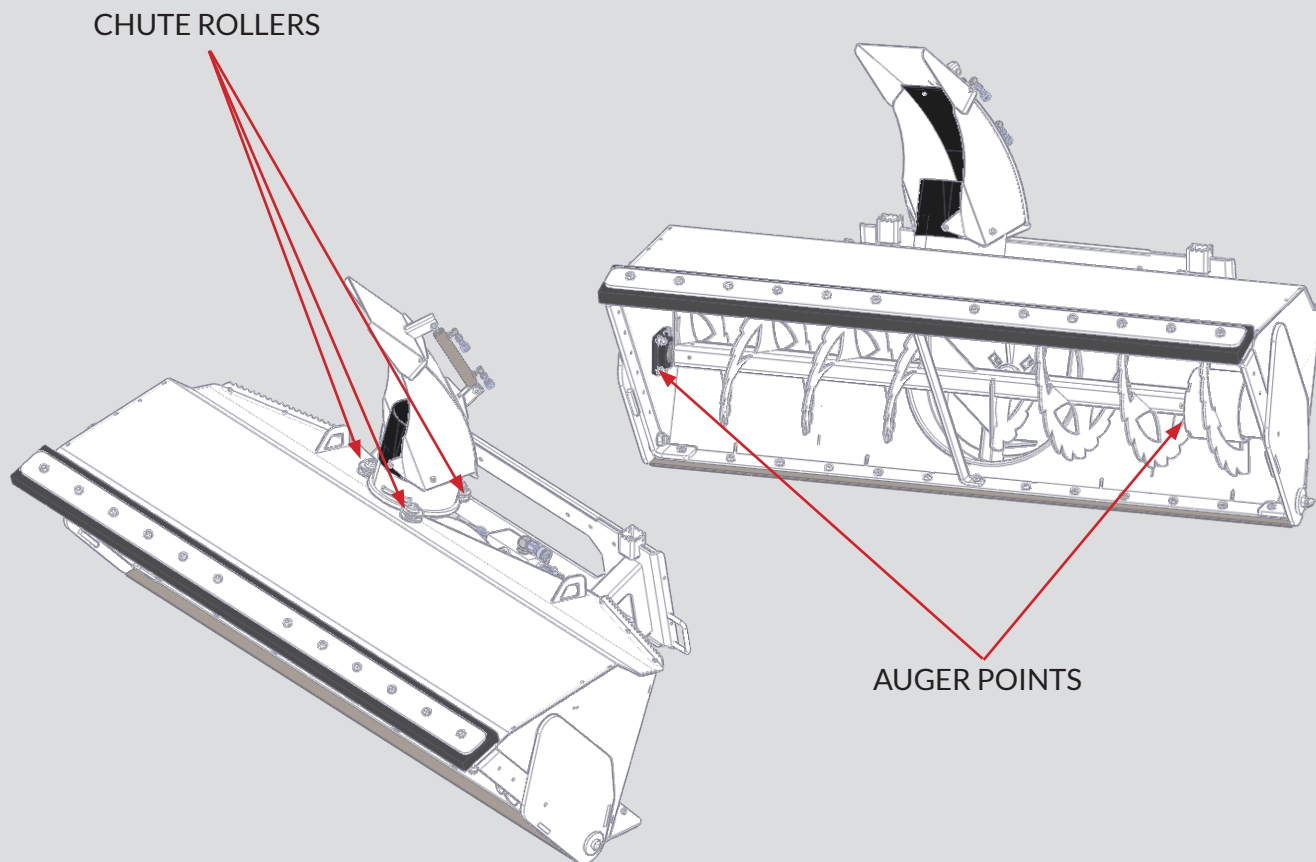

Watch our series of maintenance videos at [www.muskoxmn.com/22-78](http://www.muskoxmn.com/22-78)

# MAINTENANCE VIDEOS AND RESOURCES

Muskox Removing Blower Motor

Muskox Snowblowers

▶ Play Video

Muskox Removing Blower Motor

Next →

## LOCATING MAINTENANCE VIDEOS AND RESOURCES

To review our extensive library of step-by-step maintenance videos and resources, please visit [www.muskoxmn.com/22-78-maintenance-videos](http://www.muskoxmn.com/22-78-maintenance-videos)

# TROUBLESHOOTING

PROBLEM	POSSIBLE CAUSE	POSSIBLE SOLUTION
Auger will not rotate	Hoses installed incorrectly	Switch quick coupler fittings
	Hydraulic valve on skid steer not engaged	See skid steer operator's manual for auxiliary operation procedure
	Worn, damaged, insufficient or inadequate pump	Repair or replace hydraulic pump
	Insufficient oil in system	Service the skid steer hydraulic reservoir, see skid steer operator's manual
	Hose ends not completely engaged	Check hose couplings and engage properly
	Air in hydraulic lines	Cycle skid steer auxiliary system several times to remove air from lines
	Obstruction in hydraulic lines	Replace obstructed or damaged line
Chute will not rotate/angle	Hydraulic valve on skid steer not engaged	See skid steer operator's manual for auxiliary hydraulic operation procedure
	Worn, damaged, insufficient or inadequate pump	Repair or replace hydraulic pump
	Insufficient oil in system	Service the skid steer hydraulic reservoir, see skid steer operator's manual
	Hose ends not completely engaged	Hose ends not completely engaged
	Air in hydraulic lines	Cycle skid steer auxiliary system several times to remove air from lines
	Obstruction in hydraulic lines	Replace obstructed or damaged line
	Electrical failure	See skid steer operator's manual
Oil leaks	Worn or damaged seal	Replace leaking seal
	Loose or damaged hoses	Replace damaged hoses and secure loose hoses
	Loose or damaged connections	Replace damaged hose connections and tighten loose fittings



Refer to our video resources online for more information on this and other maintenance issues at [www.muskoxmn.com/22-78](http://www.muskoxmn.com/22-78)

# BOLT TORQUE SPECIFICATIONS

## GENERAL TORQUE SPECIFICATION TABLE

Use the following chart when determining bolt torque specifications when special torques are not given. Always use grade 5 or better when replacing bolts.

## SAE BOLT TORQUE SPECIFICATIONS

**NOTE:** The following torque values are for use with extreme pressure lubricants, plating or hard washer applications. Increase torque 15 when using hardware that is unplated and either dry or lubricated with engine oil.

Bolt Size		SAE GRADE 5 TORQUE				SAE GRADE 8 TORQUE			
		Pounds Feet		Newton-Meters		Pounds Feet		Newton Meters	
Inches	Millimeters	UNC	UNF	UNC	UNF	UNC	UNF	UNC	UNF
1/4	6.35	8	9	11	12	10	13	14	18
5/16	7.94	14	17	19	23	20	25	27	34
3/8	9.53	30	36	41	49	38	46	52	62
7/16	11.11	46	54	62	73	60	71	81	96
1/2	12.70	68	82	92	111	94	112	127	152
9/16	14.29	94	112	127	152	136	163	184	221
5/8	15.88	128	153	174	207	187	224	254	304
3/4	19.05	230	275	312	373	323	395	438	536
7/8	22.23	340	408	461	553	510	612	691	830
1	25.40	493	592	668	803	765	918	1037	1245
1-1/8	25.58	680	748	922	1014	1088	1224	1475	1660
1-1/4	31.75	952	1054	1291	1429	1547	1700	2097	2305
1-3/8	34.93	1241	1428	1683	1936	2023	2312	2743	3135
1-1/2	38.10	1649	1870	2236	2535	2686	3026	3642	4103

### BOLT HEAD IDENTIFICATION MARKS AS PER GRADE.

**NOTE:** Manufacturing Marks Will Vary

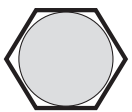

**GRADE 2**  
No Markings



**GRADE 5**  
3 Radial Lines



**GRADE 8**  
6 Radial Lines

**NOTE:** Nylock nuts are utilized when greater resistance to vibrating loose is required, and greater operating temperatures are not a factor. In addition, like lock nuts, nylock nuts have a safety feature that if the bolt does vibrate loose, the nut will remain on the screw. Install nylock nuts to the standard torque shown above.

**TORQUE SPECIFICATIONS FOR UHMW (PLASTIC) PARTS:** Fasteners attached to UHMW (plastic) parts should ONLY be tightened to secure part. DO NOT OVERTIGHTEN or damage may occur to plastic part.

# WARRANTY

## Limited Warranty

Except for the Excluded Products as described below, all new products are warranted to be free from defects in material and/or workmanship during the Warranty Period, in accordance with and subject to the terms and conditions of this Limited Warranty.

1. Excluded Products. The following products are excluded from this Limited Warranty:
  - a. Any cable, part that engages with the ground (i.e. sprockets), bearing, teeth, tamping and/or demolition head, blade cutting edge, pilot bit, auger teeth, rubber cutting edge, UHMW glide plates, and UHMW chute that either constitutes or is part of a product.
  - b. Any product, merchandise or component that, in the opinion of MUSKOX, has been (i) misused; (ii) modified in any unauthorized manner; (iii) altered; (iv) damaged; (v) involved in an accident; or (vi) repaired using parts not obtained through MUSKOX.
2. Warranty Period. The Limited Warranty is provided only to those defects that occur during the Warranty Period, which is the period that begins on the first to occur of: (i) the date of initial purchase by an end-user, (ii) the date the product is first leased or rented, or (iii) the date that is six (6) months after the date of shipment by MUSKOX as evidenced by the invoiced shipment date (the "Commencement Date") and ends on the date that is twelve (12) months after the Commencement Date.
3. Terms and Conditions of Limited Warranty. The following terms and conditions apply to the Limited Warranty hereby provided:
  - a. Option to Repair or Replace. MUSKOX shall have the option to repair or replace the product.
  - b. Timely Repair and Notice. In order to obtain the Limited Warranty, (i) the product must

be repaired within thirty (30) days from the date of receipt of MUSKOX replacement part/s, and (ii) a claim under the warranty must be submitted to MUSKOX in writing within thirty (30) days from the date of repair.

- c. Return of Defective Part or Product. If requested by MUSKOX, the alleged defective part or product shall be shipped to MUSKOX at its manufacturing facility or other location specified by MUSKOX, with freight PRE-PAID by the claimant, to allow MUSKOX to inspect the part or product.

Claims that fail to comply with any of the above terms and conditions shall be denied.

## LIMITATIONS AND EXCLUSIONS.

THIS LIMITED WARRANTY IS IN LIEU OF ALL OTHER WARRANTIES, EXPRESS OR IMPLIED, INCLUDING WITHOUT LIMITATION THE WARRANTIES OF MERCHANTABILITY, FITNESS FOR A PARTICULAR PURPOSE AND ANY WARRANTY BASED ON A COURSE OF DEALING OR USAGE OF TRADE.

IN NO EVENT SHALL MUSKOX BE LIABLE FOR CONSEQUENTIAL OR SPECIAL DAMAGES.

IN NO EVENT SHALL MUSKOX BE LIABLE FOR ANY LOSS OR CLAIM IN AN AMOUNT IN EXCESS OF THE PURCHASE PRICE, OR, AT THE OPTION OF MUSKOX, THE REPAIR OR REPLACEMENT, OF THE PARTICULAR PRODUCT ON WHICH ANY CLAIM OF LOSS OR DAMAGE IS BASED. THIS LIMITATION OF LIABILITY APPLIES IRRESPECTIVE OF WHETHER THE CLAIM IS BASED ON BREACH OF CONTRACT, BREACH OF WARRANTY, NEGLIGENCE OR OTHER CAUSE AND WHETHER THE ALLEGED DEFECT IS DISCOVERABLE OR LATENT.







601 FIRST STREET | MENTOR, MINNESOTA 59736  
WWW.MUSKOXMN.COM | 218.288.1905 | ADAM@MUSKOX.IO